



Da Vinci Stapling

## **SureForm**

with SmartFire  
technology

Achieve more  
with your stapler.

INTUITIVE



# Achieve more with your stapler

SureForm™ is a new breed of stapler.

At its core is SmartFire technology, which monitors tissue compression before and during firing, making automatic adjustments to optimize the staple line.

A 120° cone of articulation gives you the freedom to approach tissue where it naturally lies, potentially reducing the need to pull it towards the stapler.<sup>1</sup>

When you choose SureForm staplers, you can reduce uncertainty and increase stapling performance like never before.<sup>1</sup>

1. Results from testing on file.



Compatible with the da Vinci X® and da Vinci Xi® surgical systems

# More maneuverability

A 120° cone of articulation gives you the freedom to maneuver your stapler and position it where you prefer.

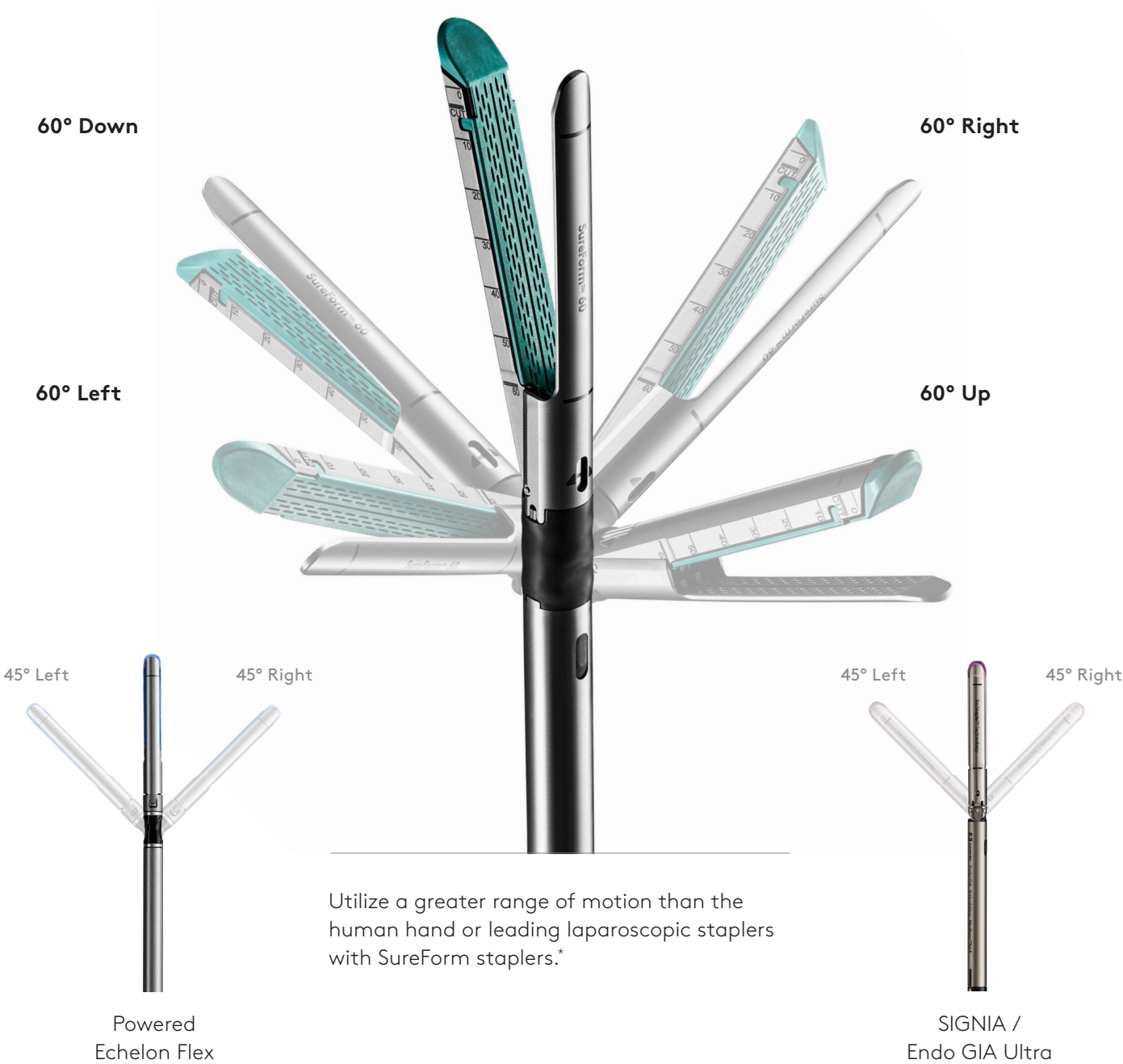

Utilize a greater range of motion than the human hand or leading laparoscopic staplers with SureForm staplers.\*

\* Compared to Endo GIA Ultra with Tri-Staple technology, SIGNIA with Tri-Staple 2.0 technology, and Powered Echelon Plus with GST as of March 2019



# More intelligence

With one press of a pedal you activate SmartFire technology, which measures tissue compression before and during firing.

SmartFire technology uses more than 1,000 measurements per second\* to make automatic adjustments to the firing process as staples are being formed and as the transection is being made.

This advanced firing technology is easy to use and helps ensure a more consistent staple line, all while preventing damage across a range of tissue thicknesses.\*\*



\* Results from testing on file

\*\* Compared to Endo GIA Ultra with Tri-Staple technology, SIGNIA with Tri-Staple 2.0 technology, and Powered Echelon Plus with GST as of March 2019.

# More optimally formed staples across a range of tissue thicknesses†

Percentage of optimally formed staples in thick tissue (>4 mm)†

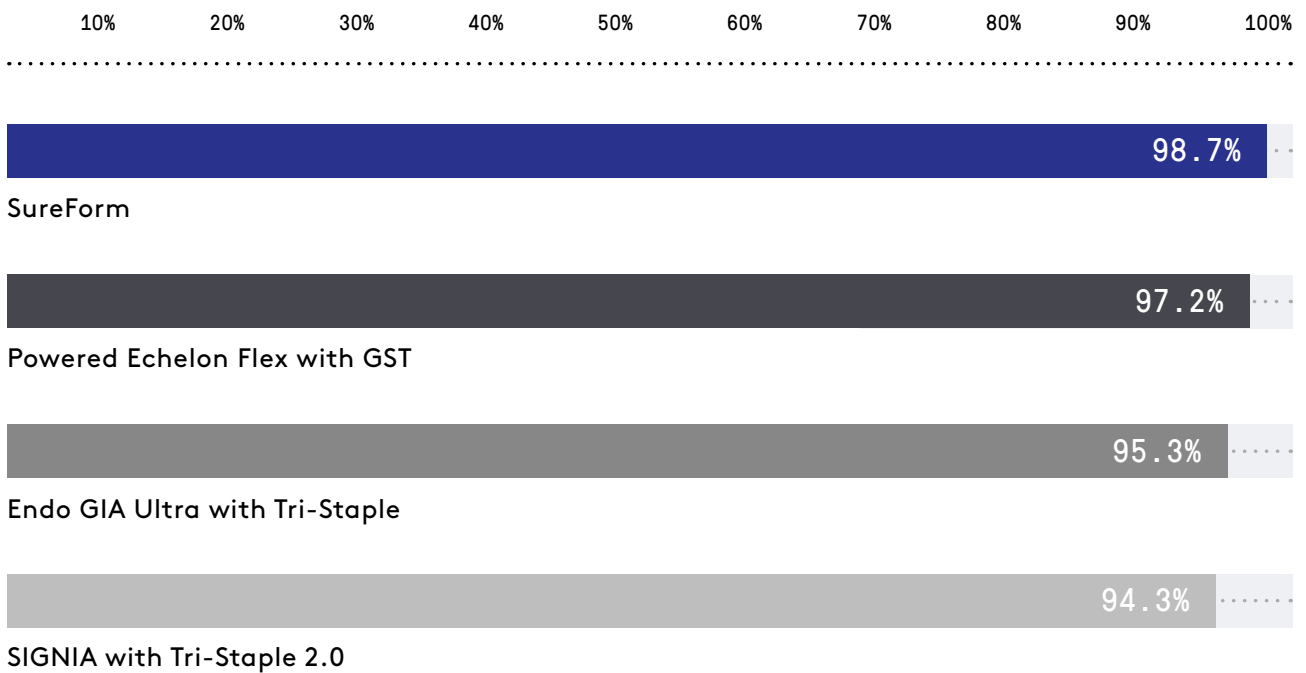

† Testing performed with black reloads on in vivo porcine stomach tissue with both 45mm and 60mm devices. Sureform 60 is significantly better than Endo GIA and SIGNIA in thick tissue. Sureform 45 is significantly better than all the three staplers in thick tissue. Data on file as of March 2019.

# Bring tissue together with less outer layer tearing†

Successful tissue approximation rate†

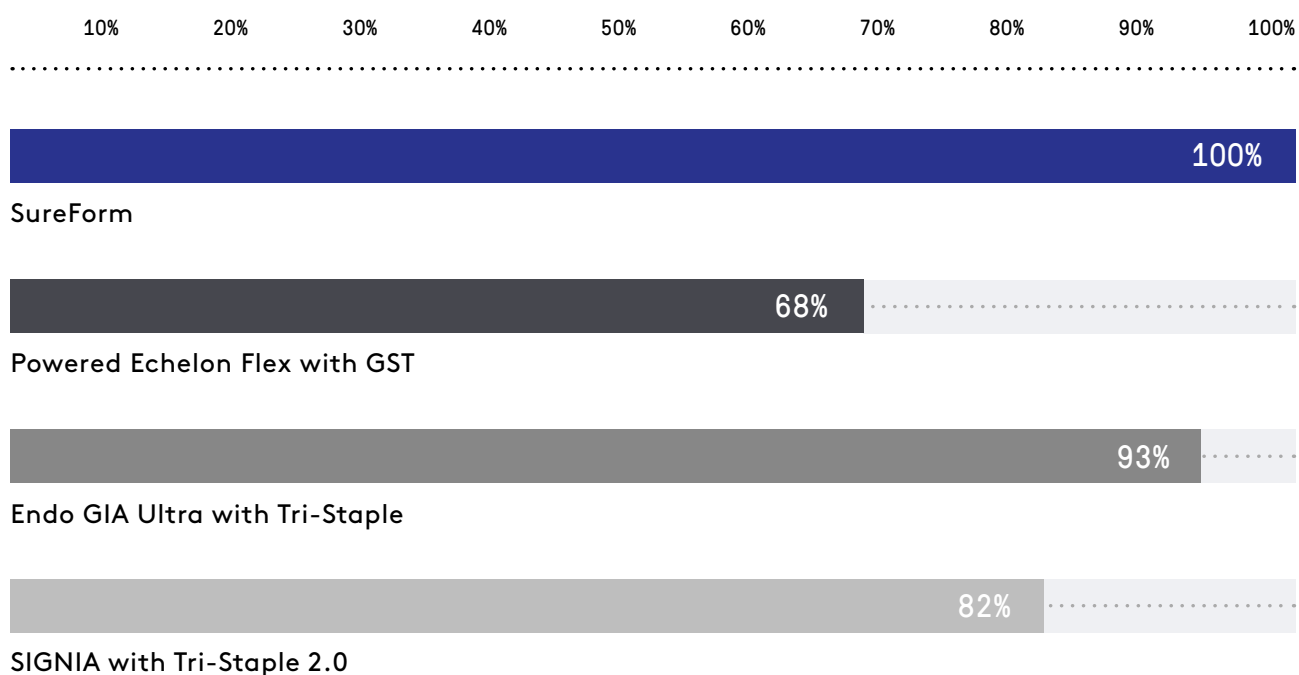

† Testing performed with black reloads on in vivo porcine stomach tissue with both 45mm and 60mm devices. SureForm 45 & SureForm 60 are significantly better than Echelon Flex. Data as of March 2019.

# More consistency

SmartFire's automatic measurements and adjustments during firing help you maintain control of the tissue.

This protects the integrity of the cut line, and helps achieve the expected length of transection.

These consistent results can help you avoid using an unanticipated reload, potentially reducing cost.

## Deliver a more consistent cut line length across thin and thick tissue.\*

Figure A: Average cutline length (60 mm staplers)

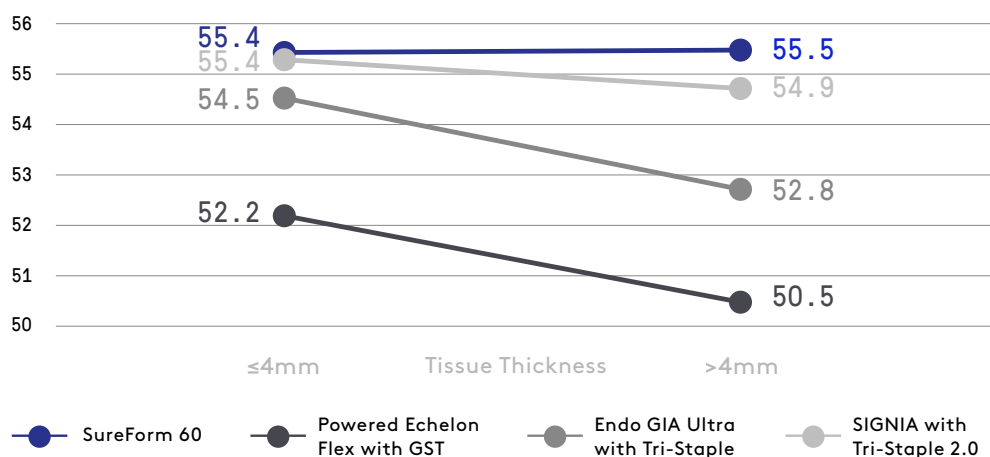
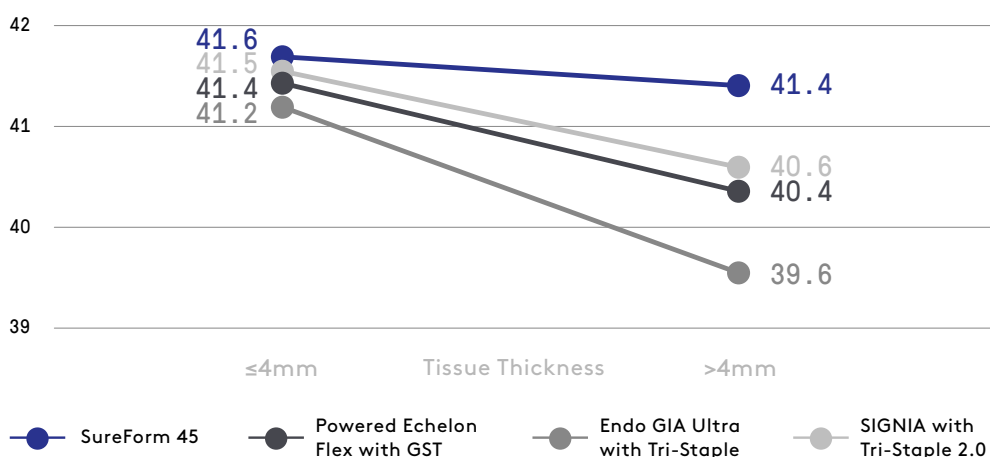

Figure B: Average cutline length (45 mm staplers)



\* Testing performed with black reloads on ex vivo porcine stomach tissue. The results of cut line consistency were determined via linear regression of the effect of tissue thickness on cut line length. The cutline length of SureForm 60 and SIGNIA with 60mm reloads were NOT significantly affected by tissue thickness, while the cutline length of Echelon Flex and Endo GIA with 60mm reloads were affected by tissue thickness (Figure A). The cutline length of SureForm 45 were NOT significantly affected by tissue thickness, while the cutline length of all three other staplers with 45mm reloads were affected by tissue thickness (Figure B). Data on file as of March 2019.



# More precision

With the full cone of articulation and anvil centric design of SureForm™ staplers, you can position the device exactly where you want, minimizing tension on the target tissue and stress to the surrounding anatomy.

## Less tension on target tissue and less stress on surrounding tissue during positioning and clamping†

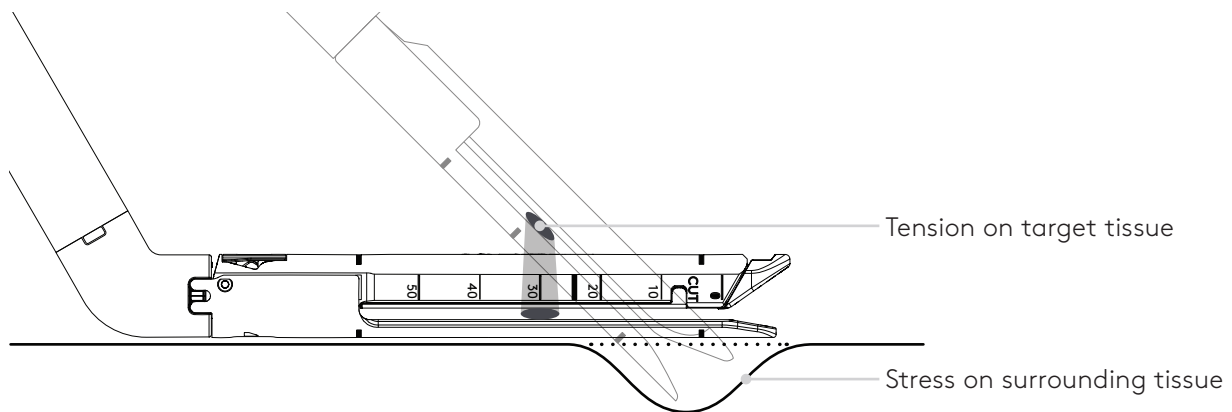

Average tension applied to target tissue while positioning and clamping stapler

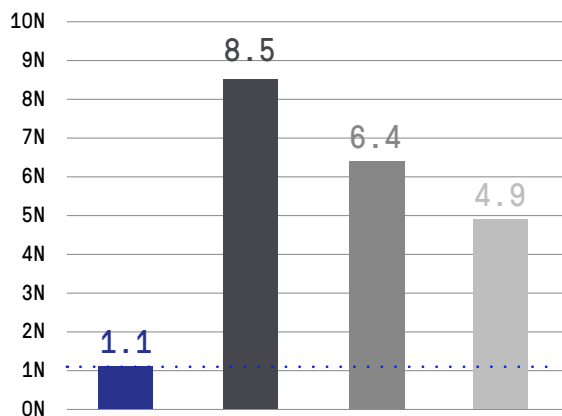

Measured in newtons as a unit of force

■ SureForm    ■ Powered Echelon Flex with GST    ■ Endo GIA Ultra with Tri-Staple    ■ SIGNIA with Tri-Staple 2.0

Average stress applied to surrounding tissue while positioning and clamping stapler

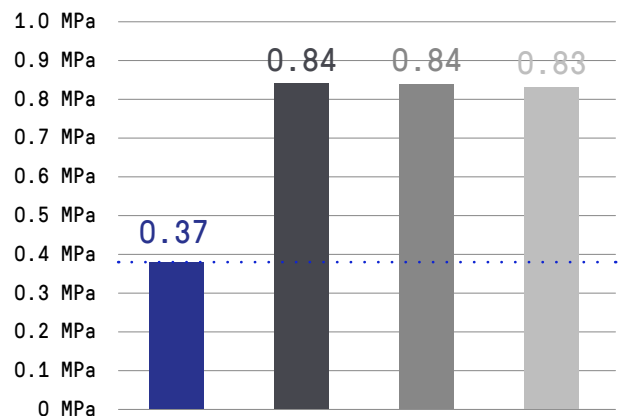

Measured in megapascals as a unit of stress

† Testing performed in benchtop surgeon evaluations. Surgeons using SureForm staplers applied significantly less target tissue tension during positioning and clamping than Echelon Flex, Endo GIA, and SIGNIA. Surgeons using SureForm staplers applied significantly less surrounding tissue stress during positioning and clamping than Echelon Flex, Endo GIA, and Signia. Data on file as of March 2019.

# More stability during firing\*

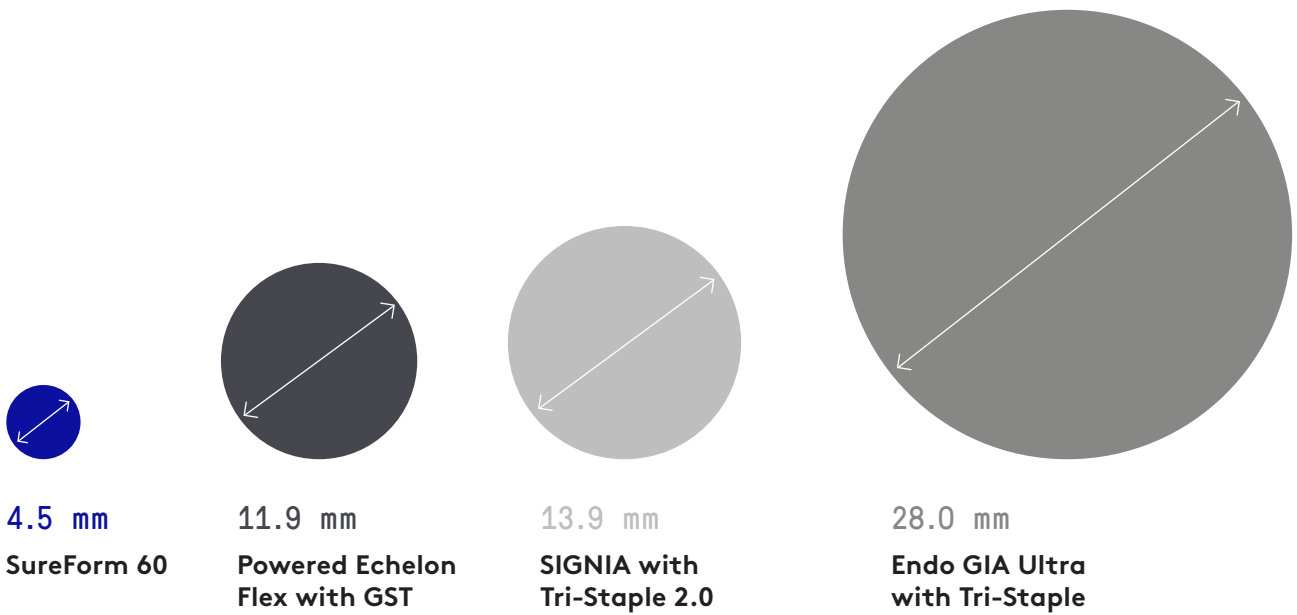

Average amount of tip movement during firing in a side-by-side benchtop test.

Images are for illustration purposes only and are not to the exact size.

\* As tested in ex vivo surgeon evaluations. SureForm 60 and competitive 60mm stapler data displayed. SureForm 45 and SureForm 60 demonstrated significantly less tip movement during firing than Echelon Flex, SIGNIA, and Endo GIA. Data on file as of March 2019.

# Additional specifications of SureForm 45 and SureForm 60

## Stapler specifications

SureForm 45: 45 mm staple line / 40 mm cut line

SureForm 60: 60 mm staple line / 55 mm cut line

An anvil centric design

Operates through a 12 mm cannula

12 fires per device

Single patient use

## Reload specifications

Gray (45mm only), White, Blue, Green, Black reloads

6 rows of staples

New knife with every reload

# SureForm 45 purchasing information



## SureForm 45

6 devices per box | 480445  
da Vinci X and da Vinci Xi



## SureForm 45 Curved-Tip

6 devices per box | 480545  
da Vinci X and da Vinci Xi



## SureForm 45 Gray Reloads

12 units per box | 48345M  
da Vinci X and da Vinci Xi



## SureForm 45 White Reloads

12 units per box | 48345W

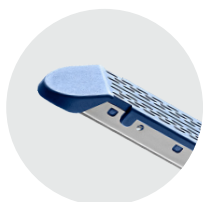

## SureForm 45 Blue Reloads

12 units per box | 48345B



## SureForm 45 Green Reloads

12 units per box | 48345G



## SureForm 45 Black Reloads

12 units per box | 48345T

### To contact a representative or receive additional information:

Visit [www.intuitive.com](http://www.intuitive.com) or call Intuitive Customer Service in the U.S. at 1.877.408.3872, in Europe at +41.21.821.2020 or +800.0821.2020 or in the rest of the world, 1.408.523.2100.



# SureForm 60 purchasing information



## SureForm 60

6 devices per box | 480460

da Vinci X and da Vinci Xi



## SureForm 60 White Reloads

12 units per box | 48360W



## SureForm 60 Blue Reloads

12 units per box | 48360B



## SureForm 60 Green Reloads

12 units per box | 48360G



## SureForm 60 Black Reloads

12 units per box | 48360T

### To contact a representative or receive additional information:

Visit [www.intuitive.com](http://www.intuitive.com) or call Intuitive Customer Service in the U.S. at 1.877.408.3872, in Europe at +41.21.821.2020 or +800.0821.2020 or in the rest of the world, 1.408.523.2100.

# Stapler accessory purchasing information

## Cannulas

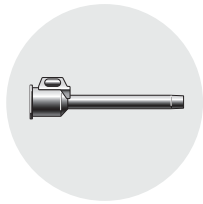

**12 mm & Stapler  
Cannula (100 mm)**  
1 unit per box  
(reusable) | 470375

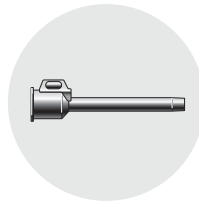

**12 mm & Stapler  
Cannula (150 mm)**  
1 unit per box  
(reusable) | 470389

## Obturators

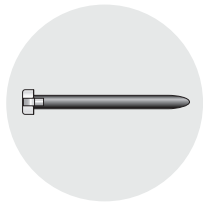

**12 mm & Stapler  
Blunt Obturator**  
1 unit per box  
(reusable) | 470376

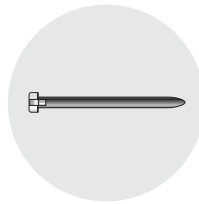

**12 mm & Stapler  
Blunt Obturator, Long**  
1 unit per box  
(reusable) | 470390



**12 mm & Stapler  
Bladeless Obturator**  
1 unit per box  
(reusable) | 470395



**12 mm & Stapler Bladeless  
Obturator, Long**  
1 unit per box  
(reusable) | 470396

## Disposables

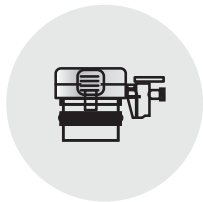

**12 mm & Stapler  
Cannula Seal**  
10 unit per box | 470380



**12 - 8 mm Reducer**  
6 units per box | 470381

### To contact a representative or receive additional information:

Visit [www.intuitive.com](http://www.intuitive.com) or call Intuitive Customer Service in the U.S. at 1.877.408.3872, in Europe at +41.21.821.2020 or +800.0821.2020 or in the rest of the world, 1.408.523.2100.

---

## **Disclosure**

The comparative studies highlighted in this document were performed in a benchtop setting, in vivo, or in a virtual setting and were not statistically powered to show the differences seen. The significance level to detect statistically significant differences was set at  $p < 0.05$ .

## **Important safety information**

Serious complications may occur in any surgery, including da Vinci® Surgery, up to and including death. Examples of serious or life-threatening complications, which may require prolonged and/or unexpected hospitalization and/or reoperation, include but are not limited to, one or more of the following: injury to tissues/organs, bleeding, infection and internal scarring that can cause long-lasting dysfunction/pain.

Risks specific to minimally invasive surgery, including da Vinci Surgery, include but are not limited to, one or more of the following: temporary pain/nerve injury associated with positioning; a longer operative time, the need to convert to an open approach, or the need for additional or larger incision sites. Converting the procedure could result in a longer operative time, a longer time under anesthesia, and could lead to increased complications. Contraindications applicable to the use of conventional endoscopic instruments also apply to the use of all da Vinci instruments.

For Important Safety Information, indications for use, risks, full cautions and warnings, please also refer to [www.intuitive.com/safety](http://www.intuitive.com/safety).

Individuals' outcomes may depend on a number of factors, including but not limited to patient characteristics, disease characteristics and/or surgeon experience.

The Intuitive Surgical Stapler SureForm™ 60, Stapler SureForm 60 reloads, and other stapler accessories are intended to be used with a compatible da Vinci Surgical Systems for resection, transection, and, or creation of anastomoses in General, Thoracic, Gynecologic, Urologic, and Pediatric surgery. The device can be used with staple line or tissue buttressing material (natural or synthetic).

The Intuitive Surgical SureForm 45 Stapler, SureForm 45 Reloads and other stapler accessories are intended to be used with a compatible da Vinci Surgical System for resection, transection, and, or creation of anastomoses in General, Thoracic, Gynecologic, Urologic, and Pediatric surgery. The device can be used with staple line or tissue buttressing material (natural or synthetic).

Unless otherwise noted, all people depicted are models.

© 2019 Intuitive Surgical, Inc. All rights reserved. Product and brand names/logos are trademarks or registered trademarks of Intuitive Surgical or their respective owner. See [www.intuitive.com/trademarks](http://www.intuitive.com/trademarks).



INTUITIVE